

Przegląd produktów rolety zewnętrzne - radiowe

VarioCom (Slide)



LumeroCom



MonoCom (Slide)



TempoTel 2

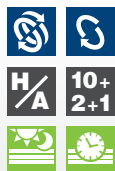

VarioTel 2



LumeroTel 2



MonoTel 2



MultiTel 2



MultiTec Touch-868

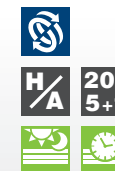

Centro Home



RolMotion-868 / RolTop-868

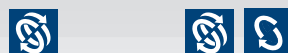

VariEco-868



QuinTec-868



MonoTec-868



AstroTec-868 /bidi



UniTec-868



UniClic-868



Invio-868
(Odbiornik radiowy)



Czujniki radiowe

Lumo-868



Lumero-868



-  Dwukierunkowe radio
-  Jednokierunkowe radio
-  Dostęp zdalny
-  Zasilanie solarne
-  Ręczny/automatyczny Przelączane
-  Indywidualny / grupowy / Kanały centralne
-  Kontrola czasowa
-  Czujnik słońca
-  Funkcja zmierzchu
-  Funkcja astro

Przegląd produktów rolet zewnętrznych - w połączeniu z odbiornikami radiowymi

VarioCom (Slide)



LumeroCom



MonoCom (Slide)



TempoTel 2

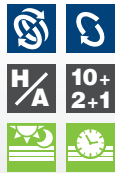

VarioTel 2



LumeroTel 2



MonoTel 2



MultiTel 2



MultiTec Touch-868

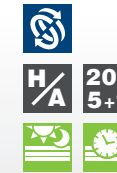

Centro Home

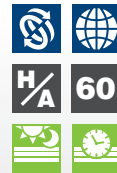

RolMotion / RolTop / VariEco



Revio-868
(Odbiornik radiowy)



Combio-868 RM*



VarioTec-868



QuinTec-868



MonoTec-868



AstroTec-868 /bidi



UniTec-868



UniClic-868



Invio-868
(Odbiornik radiowy)



Czujniki radiowe

Lumo-868



Lumero-868



-  Dwukierunkowe radio
-  Jednokierunkowe radio
-  Dostęp zdalny
-  Zasilanie solarne
-  Ręczny/automatyczny Przełączane
-  10+ 2+1 Indywidualny / grupowy / Kanały centralne
-  Kontrola czasowa
-  Czujnik słońca
-  Funkcja zmierzchu
-  Funkcja astro

* dostępne w różnych wersjach RM

Przegląd produktów żaluzje radiowe

VarioCom (Slide)



LumeroCom



MonoCom (Slide)



TempoTel 2

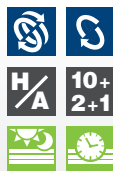

VarioTel 2



LumeroTel 2



MonoTel 2



MultiTel 2



MultiTec Touch-868

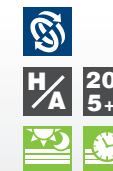

Centro Home

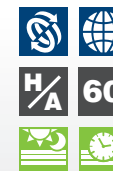

JA Comfort-868



QuinTec-868



MonoTec-868



AstroTec-868 /bidi



UniTec-868



Invio-868



Czujniki radiowe

Sensero-868 AC/Plus



Aero-868 AC/Plus



Lumo-868



Lumero-868



-  Dwukierunkowe radio
-  Jednokierunkowe radio
-  Dostęp zdalny
-  Zasilanie solarne
-  Ręczny/automatyczny
-  Przełączane Indywidualny / grupowy / Kanały centralne
-  Kontrola czasowa
-  Czujnik słońca
-  Czujnik wiatru
-  Czujnik deszczu
-  Funkcja astro
-  Funkcja zmierzchu

¹ tylko wersja plus

² tylko wersja AC

Przegląd produktów żaluzji - w połączeniu z odbiornikami radiowymi

VarioCom (Slide)	LumeroCom	MonoCom (Slide)	TempoTel 2	VarioTel 2	LumeroTel 2	MonoTel 2	MultiTel 2	MultiTec Touch-868	Centro Home
									
 H/A 6+1+1	 H/A 1	 1	 H/A 10+2+1  	 H/A 5+1	 H/A 1	 1	 H/A 15+5+1	 H/A 20+5+1  	 H/A 60  

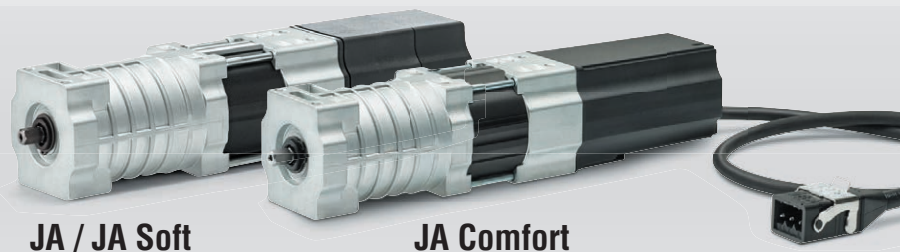

Revio-868 (Odbiornik radiowy) + **Combio-868 JA / JA Pulse** + **VarioTec-868**













QuinTec-868	MonoTec-868	AstroTec-868 /bidi	UniTec-868	Invio-868 (Odbiornik radiowy)
				
 H/A 5+1	 1	 H/A 1  	 H/A 1	 1

Czujniki radiowe

Sensero-868 AC/Plus	Aero-868 AC/Plus	Lumo-868	Lumero-868
			
    ¹	   ² 	   	   

¹ tylko wersja plus

² tylko wersja AC

-  Dwukierunkowe radio
-  Jednokierunkowe radio
-  Dostęp zdalny
-  Zasilanie solarne
-  Ręczny/automatyczny
-  Przełączane
-  Indywidualny / grupowy / Kanały centralne
-  Kontrola czasowa
-  Czujnik słońca
-  Czujnik wiatru
-  Czujnik deszczu
-  Funkcja astro
- Funkcja zmierzchu

Przegląd produktów do markiz - radiowe

VarioCom (Slide)



LumeroCom



MultiTel 2



VarioTel 2



LumeroTel 2



Centro Home

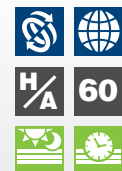

- | | | | |
|---|--|---|------------------|
|  | Dwukierunkowe radio |  | Kontrola czasowa |
|  | Jednokierunkowe radio |  | Czujnik słońca |
|  | Dostęp zdalny |  | Czujnik deszczu |
|  | Zasilanie solarne |  | Czujnik wiatru |
|  | Ręczny/automatyczny
Przełączane |  | Funkcja astro |
|  | Indywidualny / grupowy /
Kanały centralne | | |



SunTop-868



VariEco-868



QuinTec-868



UniTec-868



Invio-868
(Odbiornik radiowy)



Czujniki radiowe

Ventero-868



Protero-868



Sensero-868 AC/Plus



Aero-868 /AC/Plus



Lumero-868



¹ Może być używany pojedynczo lub w połączeniu z innymi czujnikami

² tylko wersja plus

³ tylko wersja AC

Przegląd produktów do markiz - w połączeniu z odbiornikami radiowymi

a Nice company

VarioCom (Slide)



LumeroCom



MultiTel 2



VarioTel 2



LumeroTel 2



Centro Home

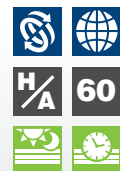

- | | | | |
|--|--|--|------------------|
| | Dwukierunkowe radio | | Kontrola czasowa |
| | Jednokierunkowe radio | | Czujnik słońca |
| | Dostęp zdalny | | Czujnik deszczu |
| | Zasilanie solarne | | Czujnik wiatru |
| | Ręczny/automatyczny
Przełączane | | Funkcja astro |
| | Indywidualny / grupowy /
Kanały centralne | | |



SunTop / VariEco

+

Revio-868
(Odbiornik radiowy)



Combio-868 RM STAK3



VarioTec-868



QuinTec-868



UniTec-868



Invio-868
(Odbiornik radiowy)



Czujniki radiowe

Ventero-868



Protero-868



Sensero-868 AC/Plus



Aero-868 /AC/Plus



Lumero-868



¹ Może być używany pojedynczo lub w połączeniu z innymi czujnikami

² tylko wersja plus

³ tylko wersja AC

Przegląd produktów - urządzenia przełączające dla światła i ciepła **e l e r o**

a Nice company

VarioCom (Slide)



LumeroCom



MonoCom (Slide)



TempoTel 2

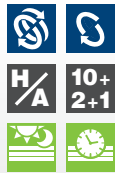

VarioTel 2



LumeroTel 2



MonoTel 2



MultiTel 2



MultiTec Touch-868

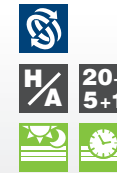

Centero Home

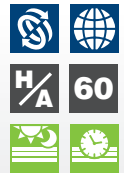

Unio-868



Combio-868 HE^{1,2}



max.
2 kW



Combio-868 LI



³
R, C



Revio-868 SW (Odbiornik radiowy)



QuinTec-868



MonoTec-868



AstroTec-868 /bidi



























UniTec-868



	Dwukierunkowe radio		Kontrola czasowa
	Jednokierunkowe radio		Czujnik słońca
	Dostęp zdalny		Funkcja astro
	Ręczny/automatyczny Przełączane		
	Indywidualny / grupowy /Kanały centralne		

¹ czas nie może być przechowywany ² nie odpowiada na kanał centralny ³ Ściemnianie 3-fazowe

Przegląd produktów -rolety - przewodowe

AstroTec	VarioTec ¹	TimeTec	TempoTec
			
      	  	   	     

Indywidualna kontrola przykładowe podłączenie

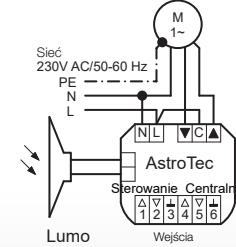

- | | | | |
|---|------------------------------------|---|--|
|  | Dwukierunkowe radio |  | Kontrola czasowa |
|  | Jednokierunkowe radio |  | Czujnik słońca |
|  | Przewodowy |  | Funkcja astro |
|  | Ręczny/automatyczny
Przełączane |  | Indywidualny /
grupowy /Kanały
centralne |

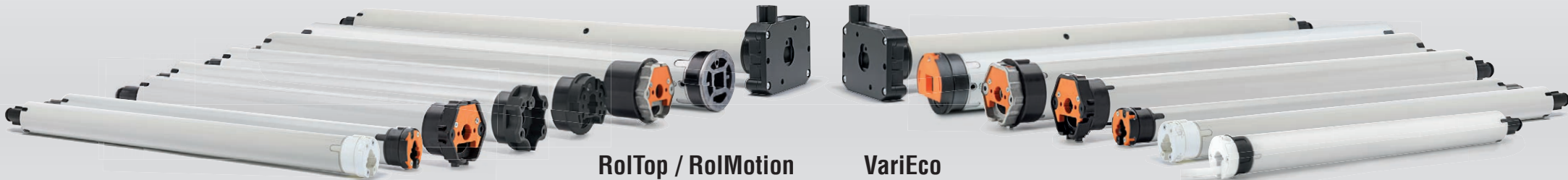

VarioTec-868 ¹	Revio-868 (Odbiornik radiowy)	MonoCom
		
    	  	 

Rysunek podłączenia do sterowania grupowego lub centralnego

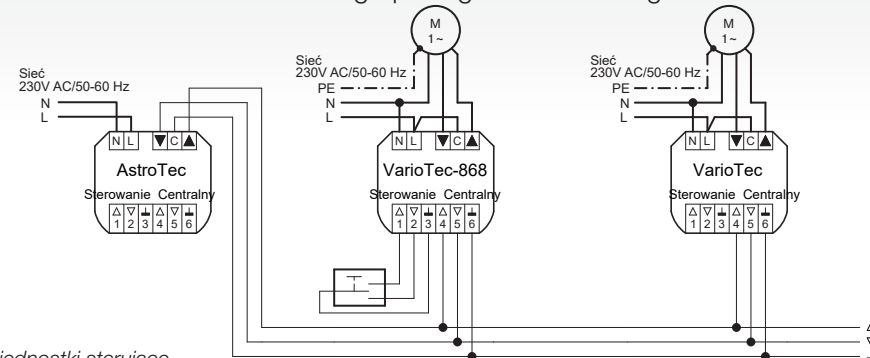

Do kolejnego urządzenia sterującego

¹ Jednostki sterujące silnikami mogą być używane jako indywidualne, grupowe lub centralne jednostki sterujące.

Przeгляд produktów do markiz - przewodowe

AeroTec¹

Indywidualna kontrola - rysunek połączenia

Aero

Ventero

Lumero

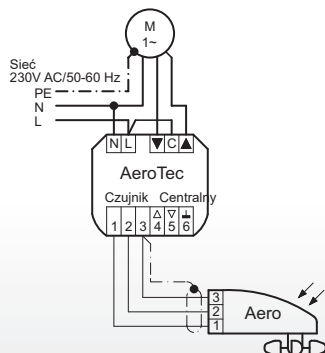

¹ stacja pogodowa jako indywidualna, grupowa lub można zastosować centralną jednostkę sterującą.

	Dwukierunkowe radio		Kontrola czasowa
	Jednokierunkowe radio		Czujnik słońca
	Przewodowy		Czujnik deszczu
	Ręczny/automatyczny Przelączane		Czujnik wiatru
	Indywidualny / grupowy /Kanały centralne		Funkcja astro



SunTop



VariEco

VarioTec-868²

VarioTec²

MonoCom

Revio-868
(Odbiornik radiowy)

Rysunek podłączenia do sterowania grupowego lub centralnego

Aquero



Objaśnienie zacisku
1 słońce / temperatura
2 wiatr
3 masa

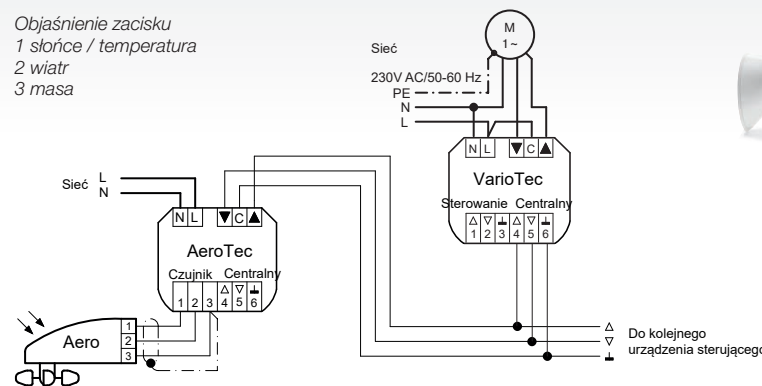

² Jednostki sterujące silnikami mogą być używane jako indywidualne, grupowe lub centralne jednostki sterujące.

Przegląd produktów żaluzje - przewodowe

AeroTec¹

Indywidualna kontrola - rysunek połączenia

Aero

Ventero

Lumero

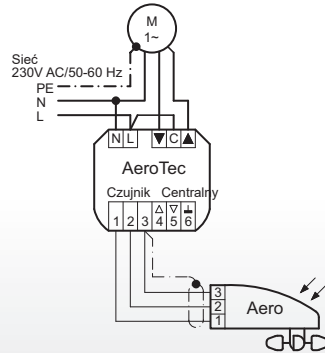

	Dwukierunkowe radio		Kontrola czasowa
	Jednokierunkowe radio		Czujnik słońca
	Przewodowy		Czujnik wiatru
	Ręczny/automatyczny Przełączane		Funkcja astro
	Indywidualny / grupowy /Kanały centralne		

¹ stacja pogodowa jako indywidualna, grupowa lub można zastosować centralną jednostkę sterującą.

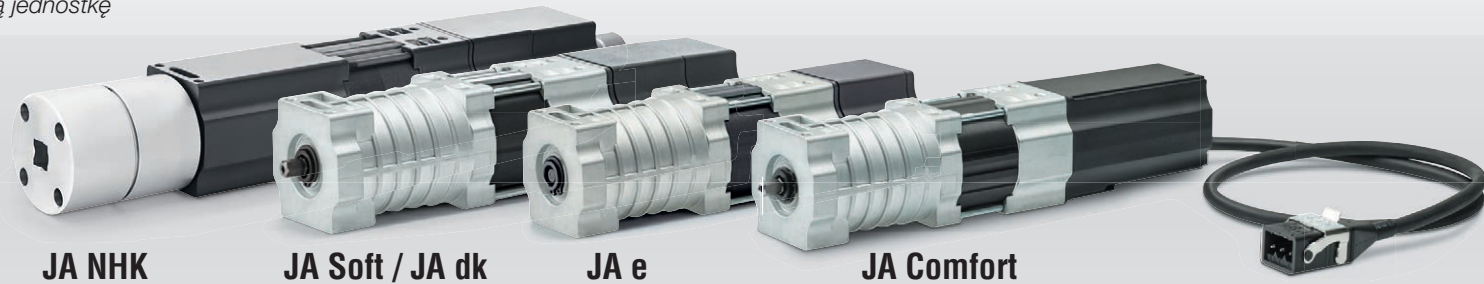

VarioTec-868²

VarioTec²

MonoCom

Revio-868
(Odbiornik radiowy)

Rysunek podłączenia do sterowania grupowego lub centralnego



Objaśnienie zacisku
1 słońce / temperatura
2 wiatr
3 masa

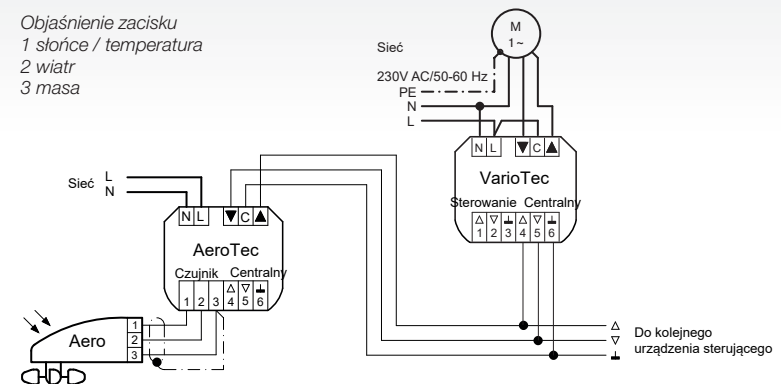

² Jednostki sterujące silnikami mogą być używane jako indywidualne, grupowe lub centralne jednostki sterujące.